

东莞东颖光电科技有限公司

DONGGUAN DONG YING OPTOELECTRONICS TECHNOLOGY CO.,LTD.

样品承认书

SPECIFICATION FOR APPROVAL

客户名 Customer	
品名 Product Name	
编号 Version number	
规格 Dimension	
材质 Texture of material	
数量 Number	
日期 Date	

制造确认 Product confirm and sign

工程部	制作部	品质部	审核	签章

检查结果 INSPECT RESULT 合格 ACCEPT 不合格 REJECT

客户确认 Customer confirm and sign

工程部	品管部	审核	确认	签章

检查结果 INSPECT RESULT 合格 ACCEPT 不合格 REJECT

说明 REMARK:

■ 样品 (sample)

产品名: _____

物料编号: _____

检验员: _____

日期: _____

Features:

- . Choice of various viewing angles
- . Available on tape and reel.
- . Reliable and robust
- . Pb free
- .The product itself will remain within RoHS compliant version.

Technical Data Sheet

This product is generally used as indicator and luminary for electronic equipment such as household appliance, communication equipment, and dashboard.

Applications

- TV set
- Monitor
- Telephone
- Computer

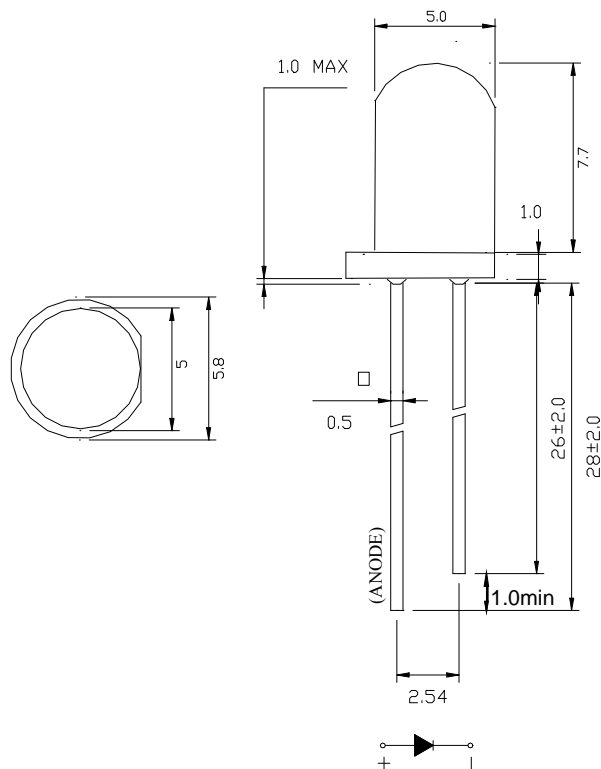
Package Dimensions:**NOTES**

- 1.All dimensions are in millimeters .
- 2.Tolerance is $\pm 0.25\text{mm}$ unless otherwise noted.

Selection Guide

Part No.	Dice	Lens Type	Luminous intensity(mcd) @ 20mA			Viewing Angle
			Min	Typ	Max	
5GG4P-Y-T	Yellow-Green (AlGaInP)	Green Diffused	25	--	55	2θ1/2 30

Note:

- 1.1/2 is the angle from optical centerline where the luminous intensity is 1/2 the optical centerline value.
- 2.the above luminous intensity measurement allowance tolerance ±15%

Electrical / Optical Characteristics at Ta=25°C

Parameter	Symbol	Min.	Typ.	Max	Units	test conditions
Forward Voltage	VF	1.8	2.0	2.4	V	IF=20mA
Reverse Current	IR	--	--	10	uA	VR = 5V
Dominate Wavelength	λd	568	--	573	nm	IF=20mA

Absolute Maximum Ratings at Ta=25°C

Parameter	Symbol	Rating	Units
Power Dissipation	Pd	60	mW
DC Forward Current	IF	20	mA
Peak Forward Current [1]	IFP	60	mA
Reverse Voltage	VR	5	V
Electrostatic Discharge	ESD	2000	V
Operating Temperature	Topr	-40~+80	°C
Storage Temperature	Tstg	-40~+100	°C
Lead Soldering Temperature [1.6mm(.063") From Body]		250°C for 5 seconds	

Note:

1. 1/10 Dut cycle,0.1ms pulse width.
2. The above forward voltage measure ment allowance tolerance ±0.1V.

Typical optical characteristics curves

Ambient Temperature VS. Forward Current

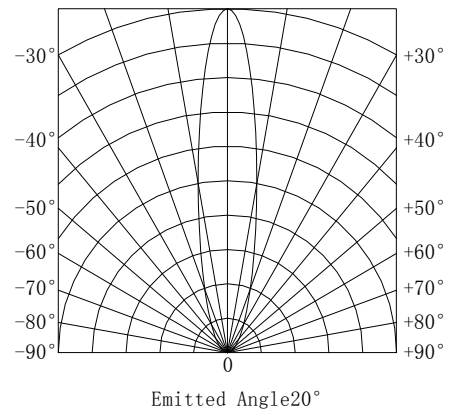
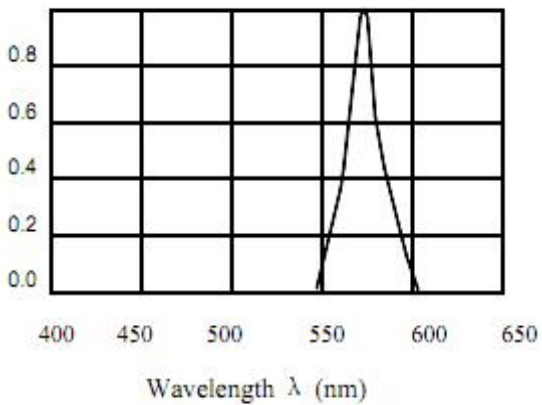
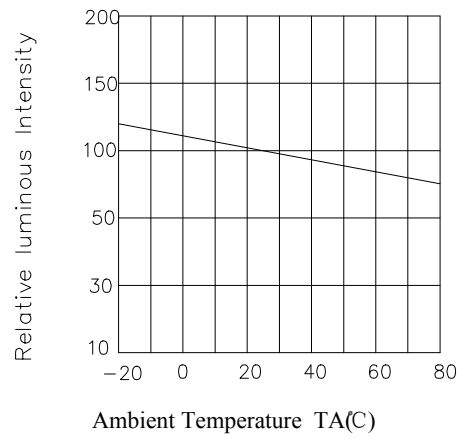
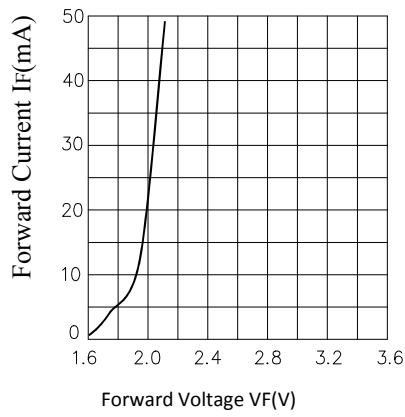
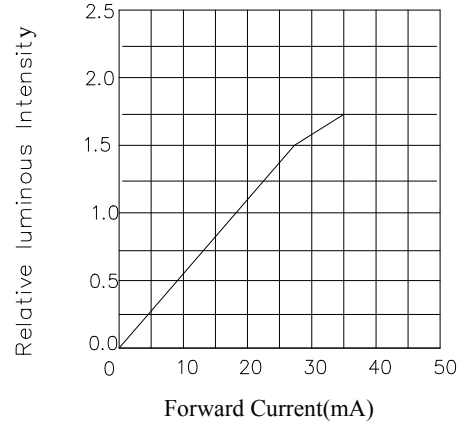
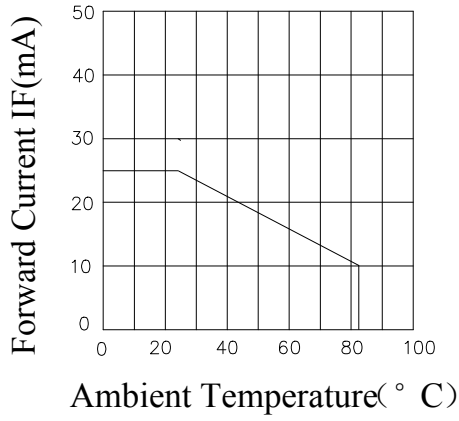

Reliability Test

Classification	Test Item	Test Condition	Sample	AC/Re
Endurance Test	Operation Life	Ta=Under Room Temperature As Per Data Sheet Maximum Rating *Test Time=1000HRS(-24HRS,+72HRS)	22	0/1
	High Temperature High Humidity Storage	Ta=85°C RH=85% Test Time=1000HRS± 2HRS	22	0/1
	High Temperature High Humidity Reverse BIAS	Ta=85°C RH=85% Test Time=500HRS(-24HRS,+48HRS)	22	0/1
	High Temperature Storage	Ta=105±5°C *Test Time=1000HRS(-24HRS,+72HRS)	22	0/1
	Low Temperature Storage	Ta=-40±5°C *Test Time=1000HRS(-24HRS,+72HRS)	22	0/1
	Environmental Test	Temperature Cycling	105°C ~ 25°C ~ -40°C ~ 25°C 30mins 5mins 30mins 5mins 10Cycles	22
Thermal Shock		105°C±5°C ~-40°C±5°C 10mins 10mins 10Cycles	22	0/1
Solder Resistance		T.sol=260±5°C Dwell Time=10±lsecs	22	0/1
Solderability		T.sol=230±5°C Dwell Time=5±lsecs	22	0/1

The appearance and specifications of the product may be modified for improvement,without prior notice.

1.Storage time

LED can be stored for a year under the condition:the temperature of 5°C-28°C and humility of RH60%,These production must be re-inspected and tested before use if their storage time exceed a year.

2.ESD countermeasure

Static electricity and high volt can damage LED,The production whose Die material is InGa must strictly required to prevent ESD,must put on static glove and static fillet,Soldering tool and the cover of device must connect the ground, soldering condition follows the related stating of production specification manual.

3.Soldering

When soldering leave a minimum of 2mm clearance from the base of the lens to the soldering point.

Dipping the lens into the solder must be avoided.

Do not apply any external stress to the lead frame during soldering while the LED is at high temperature.

Recommended soldering conditions:

Soldering iron		Wave soldering	
Temperature	320°C Max	Pre-heat Pre-heat time	100°C Max 60 sec.Max
Soldering time	3 sec.Max (one time only)	Solder wave Soldering time	250°C Max 5 sec.Max

Note: Excessive soldering temperature and/or time might result in deformation of the LED lens or catastrophic failure of the LED.

4.Drive Method

An LED is a current-operated device,In order to ensure intenity uniformity on multiple LEDs connected in parallel in an application,it is recommended that a current limiting resistor be incorporated in the drive circuit,in series with each LED as shown in Circuit A below.

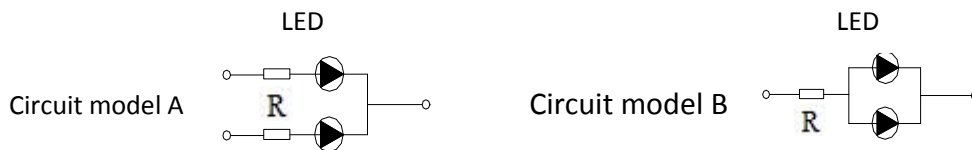

(A)Recommended circuit

(B)The brightness of each LED might appear different due to the differences in the I-V characteristics of those LEDs.

Soldering temperature curve chart

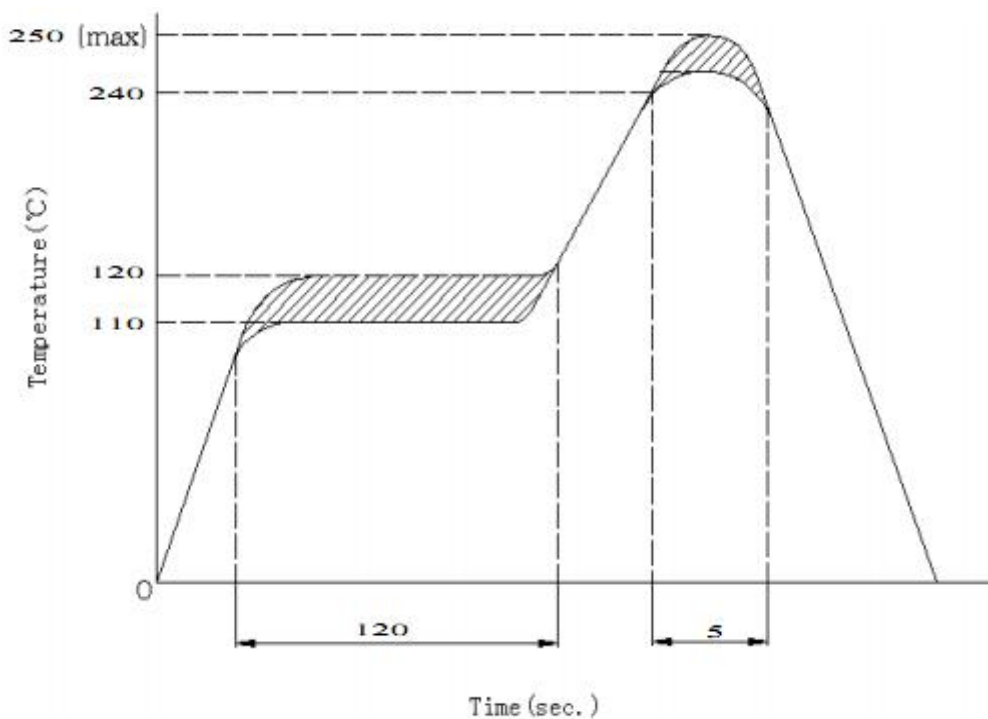

NOTES

- After soldering the LEDs, the epoxy bulb should be protected from mechanical shock or vibration until the LEDs return to room temperature.
- A rapid-rate process is not recommended for cooling the LEDs down from the peak temperature. DXJ